

OPERATION MANUAL

PEN TYPE WATER QUALITY METER



- Model:** 8351, Cond. meter
 8361, Cond.&TDS meter
 8371, Salinity meter

INTRODUCTION

Congratulations on your purchase of this pen type meter. Please read the manual completely before using this meter. Filing and keeping the manual for future reference. Recommended to soak the electrode for at least 30 min. before using to clear up the lazy effect.

Features:

- **IP65 Waterproof** housing.
- **Dual display** with ATC
- **Data hold** to freeze readings.
- **Pen size**, easy to fit in pocket.
- **Low battery** indicator.
- **Auto power off**.
- **C/F** unit switchable.
- Power by 4pcs **LR44** batteries.
- **Multi points** calibration.
- **One touch** only for calibration.

MATERIAL SUPPLIED

This package contains:

- ✓ The meter x 1
- ✓ LR44 button battery x 4
- ✓ Operation manual
- ✓ Color box or plain box

POWER SUPPLY

The meter is powered by 4 pcs LR44 batteries. To check the battery when:

1. First time use
2. The battery symbol appears on LCD
3. The meter can not power on

To install the batteries:

1. Turn off the meter.
2. Loosen the battery cover in counter-clockwise direction. (DON'T discard the black washer!)
3. Replace the old batteries with four new button cells LR44.
4. Make sure the batteries are in place and the polarity is correct.
5. Put back the battery cover and turn it tightly in clockwise direction.

NOTE:

- 1. Remove battery from instruments that you do not plan to use for a month or more. Do not leave battery in instrument.**

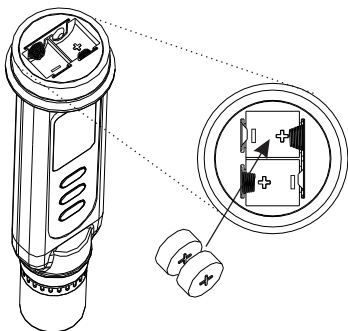

LCD DISPLAY



- The 1st display shows the measured reading.
- The 2nd display shows the reading of temp.
- Cal=Calibration mode
- Hold=Data hold
- uS or mS is the unit of Conductivity
- ppt or ppm is the unit of TDS and Salinity
- C or F is the unit of liquid temperature
-  is the battery low icon

KEYPAD

8351/8371



SET



HLD/CAL



8361



SET



HLD/CAL



MODE

OPERATION

1. Remove the probe cover from meter to expose the electrode out.
2. Press " " to power on the meter. LCD will display parameters (ex: tnr, tCo, tds, rAn) in turns and then enter normal display.

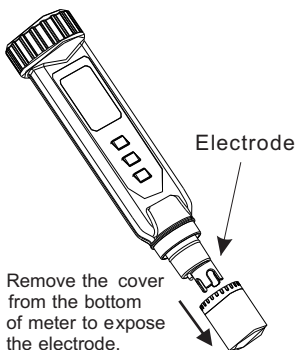

3. The meter is default in auto-ranging status once powered on. Auto-ranging determines and selects a range which gives you the greatest resolution and accuracy. Alternatively, you can manually select the ranges. For example, if you prefer the meter to display a reading as 0.50 mS instead of 500 μ S, you just need to press " ▲ " more than 2 seconds to select 19.99 mS range when you are in normal measurement mode.

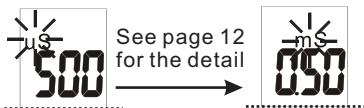

NOTE:

1. Accuracy is a percent of full-scale, so using your meter in the lowest range will result in the greatest accuracy.
2. The LCD will display E02/E03 if the measured value is below or over the limit value, please re-select the range.

4. Set the temperature coefficient to the right value. The meter is factory set to 2.1% per °C and this normally can provide good results. See page 9 to set the temperature coefficient if needed.
5. Select the normalization temperature. The meter is factory set to 25 °C. If you need to normalize the meter to 20 °C, see page 9 for the details.
6. Rinse the probe with deionized or distilled water before use to remove any impurities adhering to the electrode. If the meter is not used for a long time, please soak the probe more than 30 minutes to clear up the lazy effect of probe.
7. Dip the probe into the sample. Make sure there are no air bubbles trapped in the slot of the probe. To remove air bubbles, give the probe a gentle stir. Making sure the electrode tip is submerged when you stir it.
8. Stir the probe gently in the sample to create a homogenous sample. Allow a few seconds to reach temp. equilibrium. (Wait about 15 minutes can get a stable reading)

9. The unit of measurement will flash on the LCD to indicate the meter is in measurement mode. When the reading is stable, the unit will stop flashing.



10. Press "▼ HLD/CAL" to freeze current readings. The text "Hold" will appear on the LCD. Press "▼ HLD/CAL" again to release.



11. TDS Measurement:

In **8361** measurement mode, press "▲ MODE" to switch to conductivity or TDS mode. The units for conductivity are uS or mS. The units for TDS are ppm or ppt.

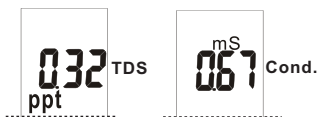

In **TDS** measurement mode, you can press "▲ MODE" more than 2 seconds to select manual ranging. (See details in page11)

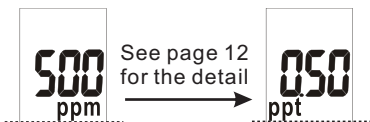

Set the TDS conversion factor to right value. The factory default is 0.50. To change the TDS factors, refer Appendix B in page 24.

12. Salinity Measurement:

8371 is designed for salt measurement. When in SALT mode, Built-in NaCl conductivity to TDS conversion factor, Temp. Coefficient and Normalization Temperature are all fixed.

You may follow up steps 3-10 to proceed the salt measurement.

13. Turn off the meter by pressing "  ".

14. Electrode Maintenance :

- a) Make sure your electrode is clean!
- b) Store the electrode carefully!
Before storage, rinse it carefully in deionised water and store dry. Put back the cap and store the meter under 0~50°C.

See the details in page 20.



14. Accuracy & Air bubbles:

The air bubbles are easy to adhere around the gap between electrode and meter and will affect the accuracy a lot. See page 21 for the details of how to remove the air bubbles.

AUTO POWER OFF (SLEEP FUNCTION)

This meter will shut off automatically 20 minutes of inactivity. For operating longer time, you can disable the sleep mode.

To disable the auto power off:

Before power on, pressing "  SET " + "  " keys simultaneously until a "n" appeared on the screen and then release keys to return to normal mode.



NOTE:

The disable sleep mode will be invalid after every power off.





SETUP





The advanced setup mode lets you customized your meter's preferences and defaults.

To change the parameters, you can press "  " more than 2 sec. to enter setup mode when the meter is in measurement mode.

P1.0: temperature parameter setting: (t)

P1.1: Change temperature unit (tUt):

When meter is in measurement mode, press "  " more than 2 sec to enter setup mode. Press "  " or "  " or "  " to select P1.0, then press "  " momentarily again to enter unit setting.

Press "  " or "  " to select C /F. Press "  " momentarily to confirm the unit or press "  " more than 2 sec to return to P1.0 without saving.

After confirming the unit, you can continuously set another temp. related parameters (except 8371) or press "  " more than 2 seconds to return to P1.0.

While in P1.0, press "  " for more than 2 seconds to return to measurement mode.

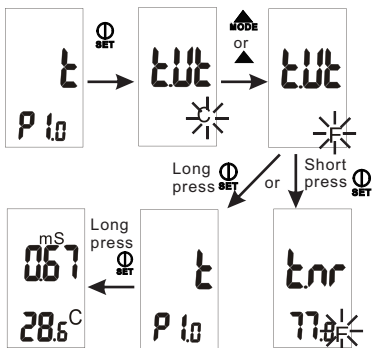

P1.2: Normalization temp.(tnr):

After saving the unit setting, the meter will automatically enter normalization temp. adjustment. Press "▲" or "MODE" to change the temperature to 20°C or 25°C. Press "SET" momentarily to confirm the value and meter will enter next step or press "SET" more than 2 sec to return to P1.0 without saving.

P1.3: Temp. Coefficient (tCo)

In temp. coefficient adjustment, press "HLD/CAL" or "▲" or "MODE" to change the temperature coefficient from 0.0 to 4.0. Press "SET" momentarily to confirm the value or press "SET" more than 2 sec to return to P1.0 without confirming the P1.3 value.

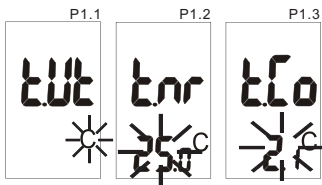

NOTE:

The text P1.1, P1.2, P1.3, P2.1, P3.1 will not display on LCD.

NOTE:

P1.2, 1.3 are invalid in 8371.

P2.0: TDS factor setting: (tdS,8361 only)

In P1.0, press "**▲** MODE" to select P2.0.

P2.1: Setting TDS factor(tds):

In P2.0, press "**⓪** SET" momentarily to enter P2.1. (P2.1 will not display on LCD). The factor will flash on LCD.

Press "**▲** MODE" or "**▼** HLD/CAL" to change factor from 0.40 to 1.00. Press "**⓪** SET" momentarily to confirm the value and meter will return to P2.0. Or pressing "**⓪** SET" more than 2 seconds to return to P2.0 without confirming the value.



NOTE:

Pay attention to the difference between short or long press "**⓪** SET" after setting the tds value.

P3.0: Reset meter: (rSt)

When you decide to reset the meter, all parameters will be reset to factor default values include the calibration info.

In P2.0, press "**▲**" or "**▲** MODE" to enter P3.0.

P3.1: Reset

In P3.0, press "**⓪** SET" momentarily to enter P3.1. Press "**▲** MODE" or "**▲**" to select Y or N. Press "**⓪** SET" momentarily to confirm the state and return to P3.0. Or press "**⓪** SET" more than 2 seconds to return to P3.0 without confirming the P3.1 value.



P4.0: Review Calibration Info.: (CAL)

In P3.0, press "▲" or "MODE" to select P4.0.

P4.1: Range 1 calibration info.:

In P4.0, press "SET" momentarily to enter P4.1 and you can see the last calibration concentration. If the meter is not yet calibrated, "---" will display on the LCD.

P4.2: Range 2 calibration info.:

In P4.1, press "▲" or "MODE" to enter P4.2 and you can see the last cal. concentration. If range 2 is not yet calibrated, "---" will display on LCD.

In P4.1 or P4.2, press "SET" momentarily to confirm the state and return to P4.0.

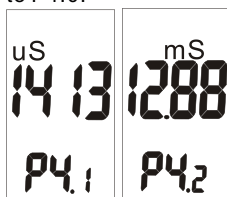

NOTE:
P4.1 & 4.2 are only for you to "review" the calibration information. Not for calibration.

NOTE:

In P1.0, P2.0, P3.0, P4.0, you can press "SET" more than 2 seconds to return to normal measurement mode.

Select measure range: (rAn, 8351/61/71)

Two measurement ranges are available for 8351/61/71. The default mode is automatically ranging.

	8351 COND.	8361 COND.	TDS	8371 SALT
Range 1	0~1999uS	0~1999uS or 1999ppm		0~10.00ppt
Range 2	0~19.99mS	0~19.99mS or 19.99ppt		10.1~70.0ppt

ppt=parts per thousand

To manually select the measurement range:

1. Turn on the meter and stay at normal measurement mode.
2. Press "▲" or "MODE" more than 2 seconds to select the range.

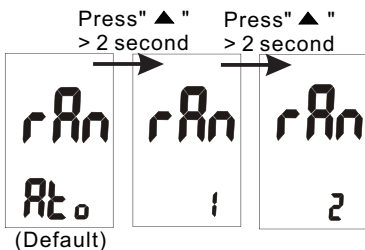

CALIBRATION MODE (CAL)

PREPARATION FOR CALIBRATION

Two issues need to be prepared and considered before operation. **First, what is the right calibration standard? Second, when should you calibrate?**

Selecting a calibration standard

For best results, select a conductivity or TDS (8361) or NaCl (8371) standard near the sample value you are measuring. Alternatively, use a calibration solution value which is approximate 2/3 of the full scale of the measurement range you plan to use.

For example, in the 0 to 1999 uS range, use 1413 uS solution for calibration.

DO NOT reuse the calibration solution. Contaminants in the solution will affect the calibration and the accuracy. Be sure to use fresh solution each time.

Please refer to below table. Strongly suggest to use the recommended solution for different conductivity and TDS ranges.

Conductivity measuring range		Recommended cal. solution range
1	0~1999uS	600~1700uS
2	0~19.99mS	6.00~17.00mS

TDS measuring range (factor=0.5)		Recommended cal. solution range
1	0.00~999ppm	300~850ppm
2	0.0~9.99ppt	3.00~8.50ppm

The previous calibration data will be replaced after re-calibration. For example, if you previously calibrated conductivity meter at 1413 uS in the 0 to 1999 uS range, when you re-calibrate it at 1500 uS again (also in the 0 to 1999uS range), the previous 1413uS will be replaced in this range (0~1999uS). However, the meter will retain the calibration data for other ranges which are not yet re-calibrated.

NOTE:

The temperature coefficient of the meter is defaulted at 2.1% per °C and provides good results for most applications. Please see Program **P1.3** on page 9 if you need to reset the coefficient.

You could also refer to **Appendix D** to calculate the temperature coefficient and determine the appropriate temperature coefficient for solution.

NOTE:

The default value of normalization temperature is 25 °C. If you need to normalize to another value, please see Program **P1.2** on page 9. Before

resetting this value, the calibration standard value of that normalized temp. must be known. You could refer to the datasheet enclosed with your solution.

When should you do the calibration?

Calibration is necessary and should be done regularly.

-If you are measuring the mid-ranges, calibrate the meter at least once a month. Soak the probe for 15 mins before calibration or measurement can saturate the probe surface and minimize drift.





-If measure at the extreme temperatures or in below concentration, calibrate the meter at least once a week to get specified accuracy.

Model	Concentration	
8351	<100uS	>2mS
8361	<100uS or <100* _{TDS factor} ppm	>2mS or >2* _{TDS factor} ppm
8371	<0.10ppt	>5.0ppt

CONDUCTIVITY CALIBRATION

Please follow up below steps to proceed the conductivity calibration:

1. Insert the probe into demineralized water or distilled water for about 30 minutes to rinse the probe.
2. Select the conductivity standard for calibration. (See page 13)
3. Pour 3 cm height of the solution into two separate clean containers.
4. Power on the meter. Select the mode as conductivity measurement mode.
5. Rinse the probe into one of above containers. Gently stir the probe.

6. Dip the rinsed probe into the other container. Tap probe on the bottom of container to remove air bubbles. Let the probe stabilize to the solution temperature (wait about 15 mins)
7. Press “ HLD/CAL “ more than 2 seconds to begin calibration. The conductivity value of solution will blink on LCD.
8. Press “ “ or “ MODE “ and “ HLD/CAL “ to change the value in order to match the value to the standard which is referred to normalization temp. 25°C You can adjust the conductivity reading up to $\pm 30\%$ from the detected value. However, if your detected value and standard value differs by more than $\pm 30\%$, it means cleaning or replacing meter is needed.

For example:

Standard: 10uS; Detected value: 19uS

Adjustable range: $\pm 5.7\text{us}$ ($19 \times 30\%$)

However, under above situation, the values already differed over 30%.

NOTE:

If the standard buffer is over the measuring limit or less than 10% of measuring limit, the displayed value will equal to the range limit or 10% of range limit.

For example 1:

Standard: 22uS; Detected value: 19uS

Adjustable range: $\pm 5.7\text{us}$ ($19 \times 30\%$)

The values differ less than 30% but the 22uS is already over range limit. So, the maximum value could be input is 19.99uS only.

For example 2:

Standard: 1.6mS; Detected :2.1mS

Adjustable range: $\pm 0.63\text{ms}$ ($2.1 * 30\%$)

The values differ less than 30% but the 1.6mS is already less than

10% range limit (1.99). So, the max. value could be input is 1.99mS only

9 When the "CAL" stop flashing, you can press "  " less than 1 second to confirm the value. The meter then return to conductivity measurement mode.

If the "CAL" always blinks, please check the calibration solutions and make sure it is stable and your input value in step 8 is correct.

10. Repeat 1~9 for other ranges if needed.

NOTE:

When switch the meter from measurement to calibration mode, the meter will display the factory default value.

So, if the meter was previously calibrated, the display may seem to jump to the factory default value when entering calibration.

NOTE:





To exit conductivity calibration mode without confirming calibration, you can press "  " (in step9) more than 2 seconds. This lets you retain the meter's previous calibration data for the current range which you proceed.

TDS CALIBRATION (MODEL:8361)

There are two options for you to do the TDS calibration.

Option1: Using TDS standards

Please follow up below steps to proceed the calibration:

1. Insert the probe into demineralized or distilled water for about 30 minutes to rinse the probe.
2. Select the TDS standard for calibration. The factory default setting of the TDS conversion factor is 0.50. If your solution has a different TDS factor, you can improve the calibration accuracy by setting the TDS factor before starting the calibration. To converse the TDS factors to the correct value, please see Appendix B or refer to the value provided by standard solution manufacturer.
3. Pour 3 cm height of the solution into two separate & clean containers.
4. Turn on the meter. Press the “ MODE “ to select TDS mode.
5. Rinse the probe into one of the containers. Gently stir the probe.
6. Dip the rinsed probe into the other container. Tap the probe on the bottom of container to remove air bubbles. Let the probe stabilize to the solution temperature.
7. Press “ HLD/CAL “ more than 2 seconds to begin the calibration. The TDS value will blink on the LCD.
8. Press the “ MODE “ or “ HLD/CAL “ to adjust the value to match the value to the standard solution which is referred to normalization temperature. The meter is defaulted at 25°C

NOTE:

Please refer to the three notes in page 15&16.

9. When "CAL" stop flashing, you can press "**⓪**" less than 1 second to confirm the value. The meter will switch back to TDS normal mode.
10. Repeat 1~9 for other ranges if needed.

Option2: Using Conversion Factors





TDS values are related to conductivity. You can calibrate the meter by using conductivity standards as described above and then program the meter with a given conversion factor. Please refer to below steps:

1. Perform the conductivity calibration procedure on page 14 ~16.
2. Select the correct Conductivity-to-TDS conversion factor. You can refer to Appendix B or calculate the TDS conversion factor for other solutions using the formula show in Appendix C
3. Refer to **P2.1** (in page 10) to check the procedures of how to set the factor.

SALT CALIBRATION (MODEL:8371)

Please follow up below steps to proceed the salinity calibration:

1. Insert the probe into demineralized or distilled water for about 30 minutes to rinse the probe.
2. Select the Sodium Chloride standard which is closed to your measurement range.

3. Pour 3 cm height of the standard into two separate & clean containers.
4. Turn on the meter.
5. Rinse the probe in one of the containers. Gently stir the probe. Rinsing could remove contaminants that affect the calibration and could prevent error.
6. Dip the rinsed probe into the other container. Tap the probe at bottom of container to remove air bubbles. Let the probe stabilize to the solution temperature.
7. Press “ HLD/CAL “ >2 sec. to begin the calibration. The SALT value will blink on the LCD.
8. Pressing the “  “ or “ HLD/CAL “ to adjust the value to match the value to the calibration standard.
You can adjust the SALT reading up to +30% from the detected value. If the detected value and standard values differs by more than +30%, it means clean electrode is needed.
9. When the “CAL” stop blinks. You can press “  SET “ to confirm the value.
The meter will switch back to SALT measurement mode.
If the “CAL” always blinks, please check the solution and make sure it is stable and the input in step 8 equals to the solution value.

NOTE:

Please refer to the three notes in page 15 & 16.

MAINTENANCE

- ✓ Make sure the electrode is clean! Between measurements, rinse the electrode with deionised water. If the electrode has been exposed to a solvent immiscible with water, clean it with a solvent miscible with water e.g. Ethanol and rinse carefully with water.
- ✓ Store the electrode carefully! Before storing, rinse it carefully in deionised water and store **dry**.

TROUBLESHOOTING

◆ Power on but no display

- 1) Make sure the time of pressing power key is more than 100 mS.
- 2) Check the battery are in place and make good contact and correct polarity.
- 3) Replace with new batteries and try again.
- 4) Move away the batteries for one minute and then put back again.

◆ Display disappear

Check whether the low battery icon is appeared before the display is off. If yes, replace with new batteries.

◆ Air bubbles adhere on electrode

The air bubbles are easy to adhere around the gap between electrode and meter. Under this situation, the accuracy will be quite poor.

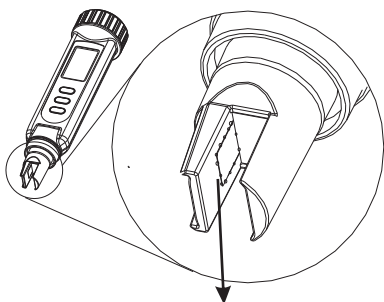

Many air bubbles adhered!

To reduce the air bubbles, stir the electrode completely and better to dip the electrode into solution at oblique angle. To dip the electrode at vertical angle is easy to create many air bubbles.

After soaking the electrode in solution for 15~30 minutes, inspect the electrode carefully to make sure no bubbles adhere. If air bubbles still exist, tap the bottom of the container gently and stir the electrode to remove the air bubbles. If above method are not working, remove the electrode out of solution and blow at the electrode to remove the air bubbles.

◆ Error code



FigA



FigB



FigC



FigD

Error Code	Meaning	How to handle?
Parameter: Conductivity (Please refer to above fig. A)		
---	Meter is in manual ranging 1 however the conductivity measured value is higher than 1999uS	Press "UP" key more than 2 seconds to change the mode to manual ranging 2 or auto ranging.
E03	Conductivity value is over the range limit (19.99mS) or meter is damage	Put the meter in standard buffer (the buffer concentration must be lower than range limit). If E03 still appear, send back for repair
E04	The original temp. error results in this error	Refer to below error code of temp. After solving the error of temp, E04 of conductivity will disappear.
Parameter: TDS (Please refer to above fig. B)		
---	Meter is in manual ranging 1 however the TDS measured value is higher than 1999*TDS factor ppm	Press "UP" key more than 2 seconds to change the mode to manual ranging 2 or auto ranging.
E04	The original temp. or conductivity error results in this error	Refer to error code of temp. & conductivity. After solving the error of temp. & conductivity, E04 of TDS will disappear.

Parameter: Salinity (Please refer to above fig. C)		
---	Meter is in manual ranging 1 however the conductivity measured value is higher than 10.0ppt	Press "UP" key more than 2 seconds to change the mode to manual ranging 2 or auto ranging.
E03	Salt value is over the range limit (70.0ppt) or meter is damage	Put the meter in standard buffer (the buffer concentration must be lower than range limit). If E03 still appear, send back for repair
E04	The original temp. or conductivity error results in this error	Refer to error code of temp. & conductivity. After solving the error of temp. & conductivity, E04 of TDS will disappear.
Parameter: Temperature (Please refer to above fig. D)		
E01	Temperature circuit is damaged	send back for repair
E02	Temp value is lower than range limit (0°C) or temperature circuit is damaged	Put the meter in room temp. for 5 mins to make the readying back to normal. If E02 still appears, send back for repair.
E03	Temp value is higher than range limit (50°C) or temperature circuit is damaged	Put the meter in room temp. for 5 mins. If E02 still appears, send back for repair.

Appendix A: Meter Factory Default Setting

Type	Parameters	Default	Remark
P1.1	Select °C/°F	°C	Temp unit
P1.2	Nor. Temp	25°C	Selectable: 25 or 20°C
P1.3	Temp. Coefficient	2.1%/°C	Adjustable from 0.4 to 10%
P2.1	TDS factor	0.50	Adjustable from 0.40 to 1.00 (only for 8361)
P3.1	Factory default	NO	Retain your current settings
P4.1	Viewing previous calibration data	---	No calibration data for 1st range
P4.2		---	No calibration data for 2nd range

Appendix B: Conductivity to TDS Conversion Factors

Conductivity at 25°C	TDS KCl		TDS NaCl		TDS 442	
	ppm value	Factor	ppm value	Factor	ppm value	Factor
23 μS	11.6	0.5043	10.7	0.4652	14.74	0.6409
84 μS	40.38	0.4807	38.04	0.4529	50.5	0.6012
447 μS	225.6	0.5047	215.5	0.4822	300	0.6712
1413 μS	744.7	0.527	702.1	0.4969	1000	0.7078
1500 μS	757.1	0.5047	737.1	0.4914	1050	0.7
2070 μS	1045	0.5048	1041	0.5029	1500	0.7246
2764 μS	1382	0.5	1414.8	0.5119	2062.7	0.7463
8974 μS	5101	0.5685	4487	0.5	7608	0.8478
12,880 μS	7447	0.5782	7230	0.5613	11,367	0.8825
15,000 μS	8759	0.5839	8532	0.5688	13,455	0.897
80mS	52,168	0.6521	48,384	0.6048	79,688	0.9961

442: 40% sodium sulfate, 40% sodium bicarbonate and 20% sodium chloride.

Appendix C: Calculating TDS conversion factors

The meter can be calibrated by using TDS calibration standard solutions. The calibration standard requires the TDS value at a standard temperature such as 25 C. To determine the Conductivity-to-TDS conversion factor, please use the following formula:

$$\text{Factor} = \text{Actual TDS} : \text{Actual Conductivity @ 25}^{\circ}\text{C}$$

Definitions:

Actual TDS: Value from the solution bottle label or from a standard buffer which made by using high purity water and precisely weighed salts.

Actual Conductivity: Value measured using a properly calibrated Conductivity/TDS/Temperature meter.

Both the actual TDS and the actual conductivity values must be in the same magnitude of units. For example, if the TDS value is ppm, the conductivity value must be in uS; if the TDS value is in ppt, the conductivity value must be in mS.

Check this number by multiplying the conductivity reading by the factor in the above formula and the result is the TDS in ppm.

Appendix D: Temperature Effect

Conductivity measurements are temperature dependent, if the temperature increases, conductivity increases. eg: the conductivity measured in a 0.01 M KCl solution at 20° C is 1.273 mS/cm, whereas, at 25 °C, it is 1.409 mS/cm.

The concept of reference temperature (Normalization temperature) was introduced to allow the comparison of conductivity results obtained at different temperature. The reference temperature is usually 20° C or 25° C. The conductivity meter measures the actual COND. and temperature and then converts it to the reference temperature using a temperature correction function and displays the conductivity at the reference temp.. It is mandatory to always associate the temperature together with a conductivity result. If no temperature correction is applied, the conductivity is the value taken at measurement temperature. The 830x meter used linear temperature correction.

Linear temperature correction:

In moderately and highly conductive solutions, temperature correction can be based on a linear equation involving a temperature coefficient (θ). The coefficient is usually expressed as a conductivity variation in %/° C.

Linear temperature correction is used, e.g. for saline, acids and leaching solutions.

$$K_{T_{ref}} = \frac{100}{100 + \theta \cdot (T - T_{ref})} \cdot K_T$$

where:

$K_{T_{ref}}$ = Conductivity at T_{ref}

K_T = Conductivity at T

T_{ref} = Reference temperature

T = Sample temperature

θ = Temperature coefficient

Note: the correction is accurate only within a limited temperature range around T_1 and T_2 . The greater the difference between T and T_{ref} , the higher the risk of error.

Calculating Temperature Coefficients (θ)

By measuring the conductivity of a sample at temperature T_1 close to T_{ref} and another temperature T_2 , you can calculate the temperature coefficient by using the following equation:

$$\theta = \frac{(K_{T_2} - K_{T_1}) \cdot 100}{(T_2 - T_1) \cdot K_{T_1}}$$

T_2 should be selected as a typical sample temperature and should be approximately 10°C different from T_1 .

The temperature coefficients of the following electrolytes generally fall into the ranges shown below:

Acids: 1.0 - 1.6%/°C

Bases: 1.8 - 2.2%/°C

Salts: 2.2 - 3.0%/°C

Drinking water: 2.0%/°C

Ultrapure water: 5.2%/°C

Average temperature coefficients of standard electrolyte solutions expressed as %/°C of the conductivity value at 25°C

Temp. Range °C	KCl 1 M	KCl 0.1 M	KCl 0.01 M	Saturated NaCl
15 - 25	1.725	1.863	1.882	1.981
15 - 25 - 35	1.730 (15 - 27°C)	1.906	1.937 (15 - 34°C)	2.041
25 - 35	1.762 (25 - 27°C)	1.978	1.997 (25 - 34°C)	2.101

SPECIFICATION

SPECIFICATIONS	8351	8361	8371
Accuracy \pm	1% Full Scale \pm 1 digit or 2% Full Scale \pm 1 digit (10.1~70.0ppt of 8371)		
Calibration	One point per range		
Auto Power Off	●	●	●
Measurement range	0~1999uS or 0~19.99mS	0~1999uS/ppm or 0~19.99mS/ppt **1	0.00~10.00 ppt (NaCl) 10.1~70.0 ppt (NaCl)
Temp. Accuracy	\pm 0.5°C	\pm 0.5°C	\pm 0.5°C
Temp. Resolution	0.1°C/°F	0.1°C/°F	0.1°C/°F
Resolution	1uS or 0.01mS	1uS/1ppm or 0.01mS/0.01ppt	0.01ppt or 0.1ppt
Hold Data	●	●	●
Unit C/F switchable	●	●	●
ATC (0~50°C)	●	●	●
View Cali. Information	●	●	●
Waterproof (IP65)	●	●	●
Size	165mm(L)x35mm(W)x32mm(T)		
TDS Factor	Built-in NaCl conductivity to TDS conversion factor		
Temp. Coefficient	0~4.0%/°C	0~4.0%/°C	Built-in NaCl Temp. Coefficient
Normalization Temp.	20 or 25°C	20 or 25°C	Fixed at 25°C

**1: This value is based on TDS factor = 1.00.

- ✓ Operating Temp.: 0°~50°C (32~122°F)
- ✓ Battery Life: >80 hrs continuous use

WARRANTY

The meter is warranted to be free from defects in material and workmanship for a period of one year from the date of purchase. This warranty covers normal operation but does not cover battery, misuse, abuse, alteration, tampering, neglect, improper maintenance, or damage resulting from leaking batteries. Proof of purchase is required for warranty repairs. Warranty is void if the meter used to be taken apart.

RETURN AUTHORIZATION

Authorization must be obtained from the supplier before returning items for any reason. When requiring a RA (Return Authorization), please include data regarding the defective reason, the meters are to be returned along with good packing to prevent any damage in shipment and insured against possible damage or loss .

OTHER RELATED PRODUCTS

Other related water quality products:

Benchtop Series

- a.86501/86551 pH,mV meter/printer
- b.86502/86552 pH, mV, ORP meter/printer
- c.86504/86554 pH, mV, ORP, Cond. meter/printer
- d.86505/86555 pH, mV, ORP, Cond.,TDS,Salinity meter
/printer

Handheld Series

- a.8601: pH, mV meter
- b.9861: pH, mV logger/ printer
- c.9661: pH, mV logger
- d.8551, 8651 ORP meter
- e.8301~06: Conductivity meter
- f.8401~03: D.O. Meter

Pen type Series

- a.8690: pH/temp. pen
- b.8680~8682: pH pen
- c.8684~8686: pH pen

Accuracy, the Zenith of Measuring / Testing Instruments !

Hygrometer/Psychrometer
Thermometer
Anemometer
Sound Level Meter
Air Flow meter
Infrared Thermometer
K type Thermometer
K.J.T. type Thermometer
K.J.T.R.S.E. type Thermometer
pH Meter
Conductivity Meter
T.D.S. Meter
D.O. Meter
Saccharimeter
Manometer
Tacho Meter
Lux / Light Meter
Moisture Meter
Data logger
Temp./RH transmitter
Wireless Transmitter

More products available !

2011/06 v02

www.ponpe.com